



[www.delonghi.com](http://www.delonghi.com)



Instructions for use. Keep these instructions  
Mode d'emploi. Conservez cette notice  
Instrucciones para el uso. Repase y guarde  
estas instrucciones. Lea cuidadosamente este  
instructivo antes de usar su aparato

**FULLY AUTOMATIC COFFEE CENTER  
MACHINE À CAFÈ AUTOMATIQUE  
CAFETERA SUPERAUTOMATICA  
ECAM26455M**



Visit [www.delonghiregistration.com](http://www.delonghiregistration.com) to register your product. Visit [www.delonghi.com](http://www.delonghi.com) for a list of service centers near you.

Visite [www.delonghiregistration.com](http://www.delonghiregistration.com) para registrar su producto en línea. Visite [www.delonghi.com](http://www.delonghi.com) para ver la lista de centros de servicios cercanos a usted.

Visitez [www.delonghiregistration.com](http://www.delonghiregistration.com) pour enregistrer votre produit en ligne. Visitez [www.delonghi.com](http://www.delonghi.com) pour y voir une liste des centres de réparation proches de chez vous.

Electric Characteristics:    Caractéristiques électriques:    Características electricas:  
120 V ~60Hz 1250W

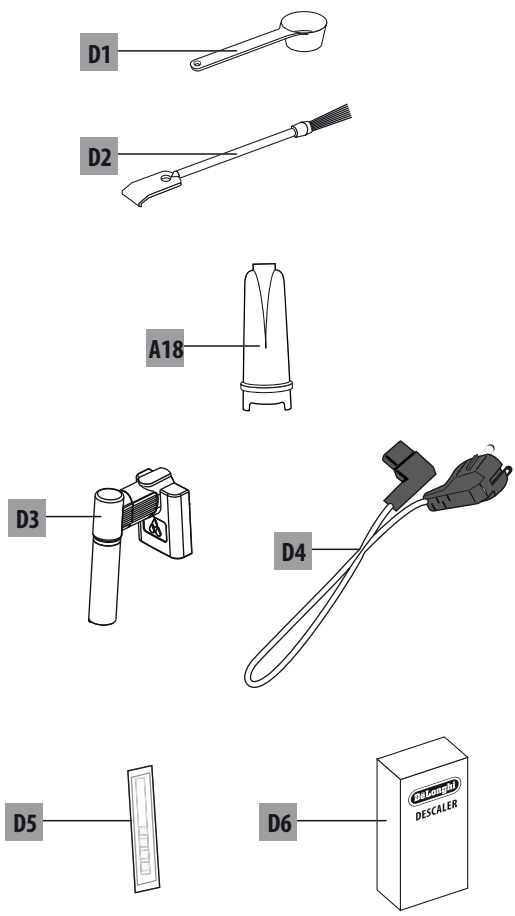
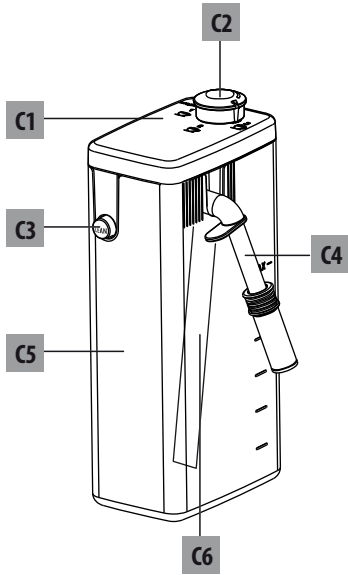
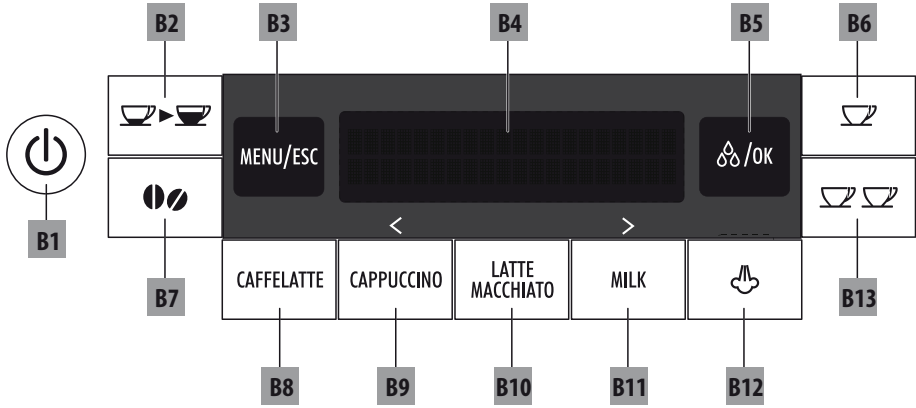

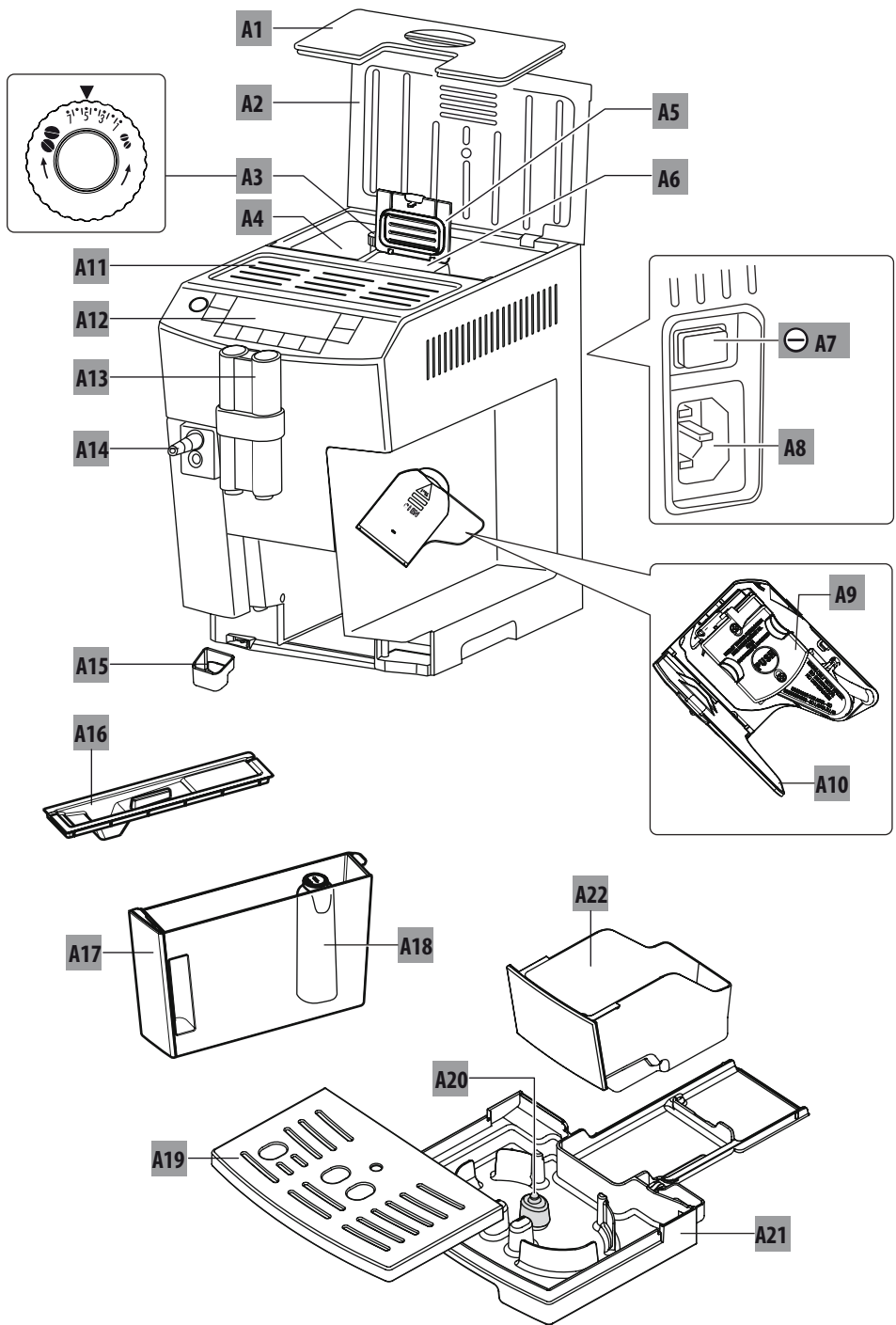

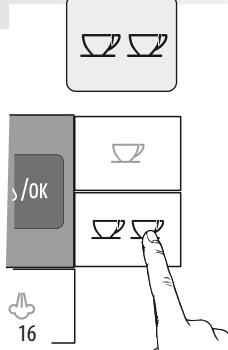
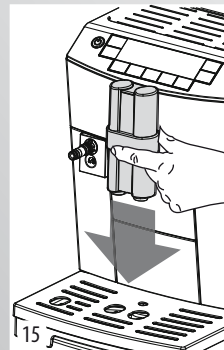
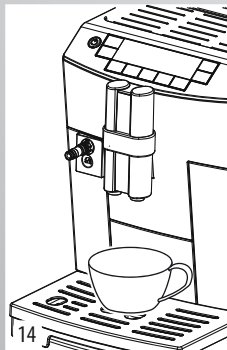
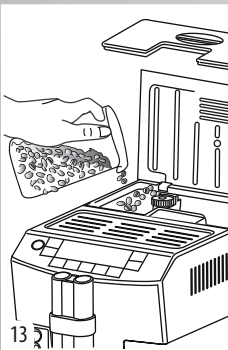
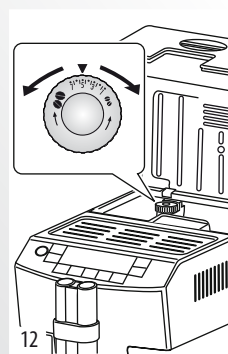
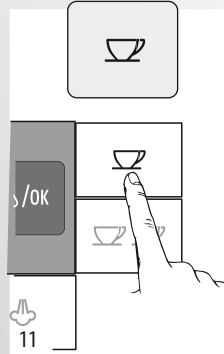
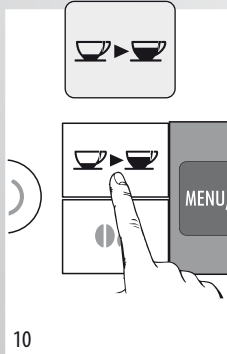
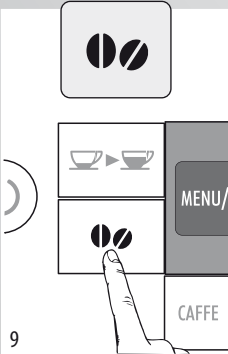
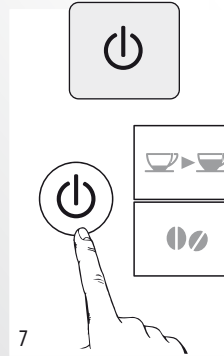
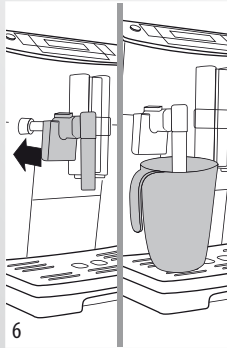
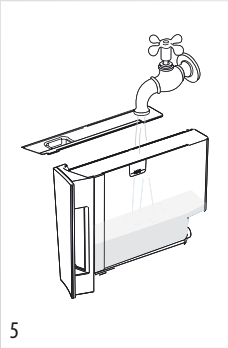
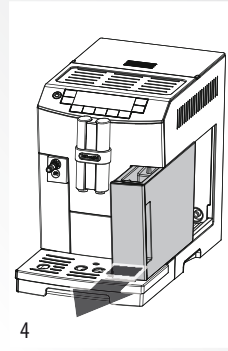
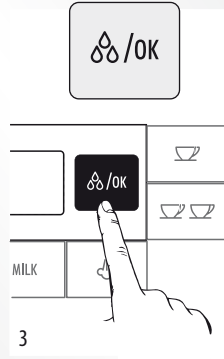
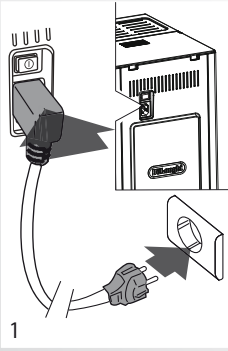

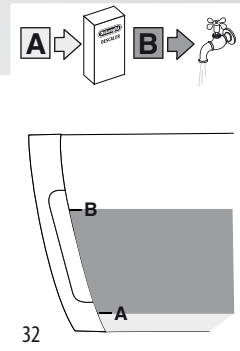
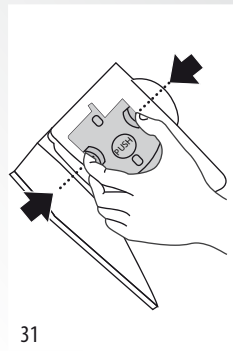
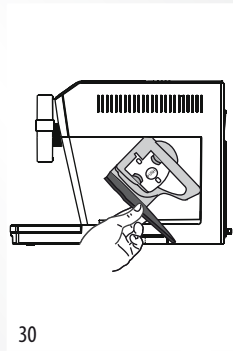
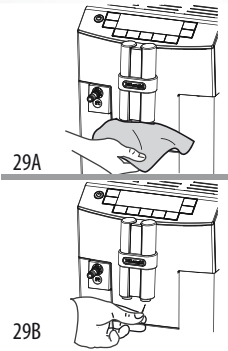
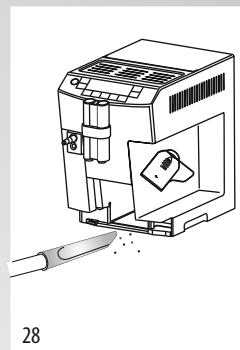
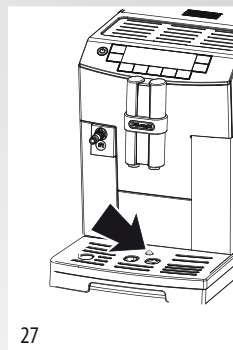
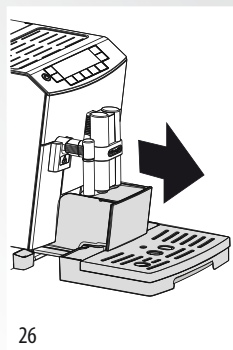
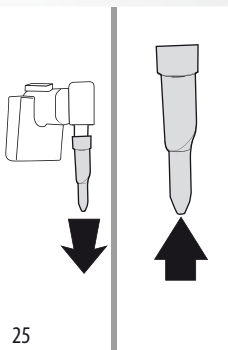
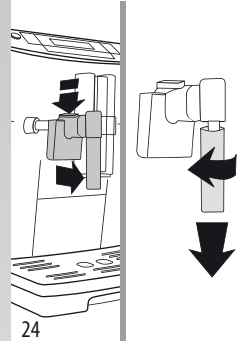
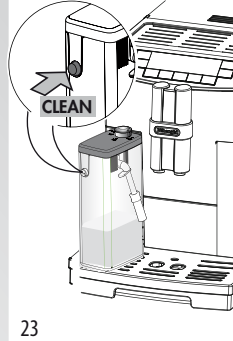
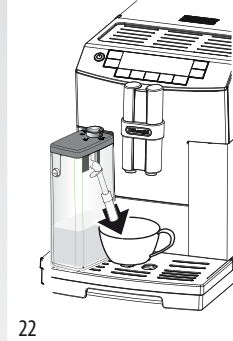
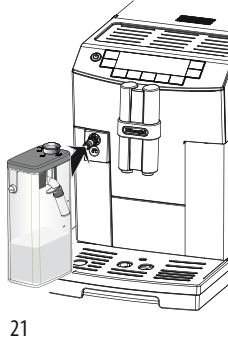
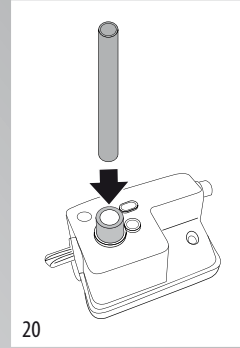
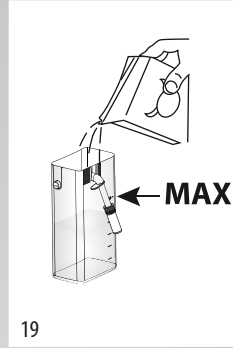
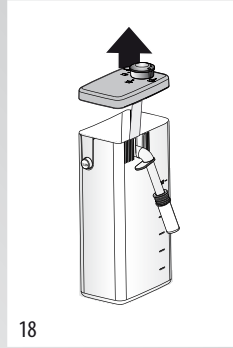
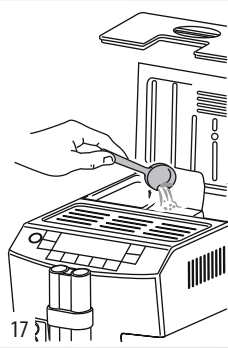

## CONTENTS

---

<b>IMPORTANT SAFEGUARDS</b> .....	<b>7</b>
SAVE THESE INSTRUCTIONS .....	7
<b>SHORT CORD INSTRUCTIONS</b> .....	<b>7</b>
<b>INTRODUCTION</b> .....	<b>8</b>
Symbols used in these instructions .....	8
Letters in brackets .....	8
Troubleshooting and repairs .....	8
<b>DESCRIPTION</b> .....	<b>8</b>
Description of the appliance .....	8
Description of the control panel .....	8
Description of the milk container .....	9
Description of the accessories .....	9
<b>PRELIMINARY CHECKS</b> .....	<b>9</b>
Checking the appliance .....	9
Installing the appliance .....	9
Using the appliance for the first time.....	9
<b>TURNING THE APPLIANCE ON</b> .....	<b>10</b>
<b>TURNING THE APPLIANCE OFF</b> .....	<b>10</b>
<b>MENU SETTINGS</b> .....	<b>10</b>
Rinsing.....	10
Descalc .....	10
Adjust time .....	10
Auto-off .....	10
Auto-start .....	10
Setting the temperature .....	11
Energy Saving .....	11
Setting water hardness .....	11
Setting the language .....	11
Install filter .....	11
Replacing the filter .....	11
Beep .....	11
Cup lighting .....	11
Default values (reset).....	12
Statistics function .....	12
<b>MAKING COFFEE</b> .....	<b>12</b>
Selecting the coffee taste.....	12
Selecting the quantity of coffee in the cup .....	12
Customising the “my coffee” quantity .....	12
Adjusting the coffee mill.....	12
Tips for a hotter coffee .....	13
Making coffee using coffee beans .....	13
Making coffee using pre-ground coffee .....	13
<b>MAKING DRINKS WITH MILK</b> .....	<b>13</b>
Filling and attaching the milk container .....	13
Adjusting the amount of froth .....	14
Making drinks with milk automatically.....	14
Cleaning the milk frother with the CLEAN button .....	14
Programming the quantity of coffee and milk in the cup for the CAFFELATTE, CAPPUCCINO, MACCHIATO and MILK buttons.....	14
<b>DELIVERING HOT WATER AND STEAM</b> .....	<b>15</b>
Delivering hot water .....	15
Change the quantity of water delivered automatically. ....	15
Delivering steam.....	15
Tips for using steam to froth milk.....	15
Cleaning the spout after use .....	15
<b>CLEANING</b> .....	<b>15</b>
Cleaning the coffee grounds container.....	15
Cleaning the drip tray and condensate tray.....	16
Cleaning the inside of the coffee maker .....	16
Cleaning the water tank.....	16
Cleaning the coffee spouts.....	16
Cleaning the pre-ground coffee funnel .....	16
Cleaning the infuser.....	16
Cleaning the milk container.....	17
Cleaning the hot water/steam nozzle .....	17
<b>DESCALE</b> .....	<b>17</b>
<b>SETTING THE WATER HARDNESS</b> .....	<b>18</b>
Measuring water hardness.....	18
Set water hardness .....	18
<b>WATER FILTER (CERTAIN MODELS ONLY)</b> .....	<b>18</b>
Installing the filter .....	18
Replacing the filter .....	19
Removing the filter .....	19
<b>TECHNICAL SPECIFICATION</b> .....	<b>19</b>
<b>DISPLAYED MESSAGES</b> .....	<b>20</b>
<b>TROUBLESHOOTING</b> .....	<b>21</b>
<b>LIMITED WARRANTY</b> .....	<b>22</b>
How does country law apply? .....	22

# IMPORTANT SAFEGUARDS

When using electrical appliances, basic safety precautions should always be followed, including the following.

- Read all instructions carefully.
- Make sure the voltage of your electrical system corresponds to the voltage shown on the bottom of the machine.
- Do not touch hot surfaces. Use handles or knobs.
- To protect against fire, electrical shock and personal injury, do not immerse cord, plug or appliance in water or other liquid.
- Keep the appliance out of the reach of children and do not leave appliance unattended while in operation.
- Unplug from the outlet when not in use and before cleaning.
- Do not operate with a damaged cord or plug, or after the appliance malfunctions, or has been damaged in any manner. Return the appliance to the nearest authorized service facility for examination, repair or adjustment.
- The use of accessory attachments not recommended by the manufacturer may result in fire, electrical shock, or personal injury.
- Do not use outdoors.
- Make sure the power cord does not hang over the edge of the table or counter-top to avoid getting accidentally caught or entangled.
- Do not place the appliance or its electrical parts on or near electric stoves, cooking surfaces, or gas burners.
- Plug cord into the wall outlet. To disconnect, first turn machine "off", then remove plug from wall outlet.
- Do not use the appliance for other than the intended use. This appliance is to be utilized for domestic use only. The manufacturer declines all responsibility for any damage caused by improper, incorrect, or irresponsible use.

**WARNING: To reduce the risk of fire or electric shock, do not remove the cover or the exterior of the unit. Don't attempt to repair or modify the machine, doing so will void the warranty. Repair should be done by authorized service personnel only!**

## SAVE THESE INSTRUCTIONS

THIS APPLIANCE IS FOR HOUSEHOLD USE ONLY

## SHORT CORD INSTRUCTIONS

- A short power cord is provided to reduce risks resulting from becoming entangled in or tripping over a longer cord.
- Longer, detachable power supply cords or extension cords are available and may be used if care is exercised in their use.
- If an extension cord is used, the marked electrical rating should be at least as great as the electrical rating of the appliance. If the appliance is provided with 3- wire, grounding type cord, the extension should be a GROUNDING TYPE 3 - WIRE CORD. The longer cord should be arranged so that it will not drape over the counter-top or table top where it can be pulled on by children or tripped over.
- Your product is equipped with a polarized alternating current line plug (a plug having one blade wider than the other). This plug will fit into the power outlet only one way. This is a safety feature. If you are unable to insert the plug fully into the outlet, try reversing the plug. If the plug should still fail to fit, contact your electrician to replace your obsolete outlet. Do not defeat the safety purpose of the polarized plug.



## INTRODUCTION

Thank you for choosing the ECAM26.455 automatic coffee and cappuccino maker.

We hope you enjoy using your new appliance.

Take a few minutes to read these instructions.

This will avoid all risks and damage to the machine.

### Symbols used in these instructions

Important warnings are identified by these symbols.

It is vitally important to observe these warnings.



*Danger!*

Failure to observe the warning could result in life threatening injury from electric shock.



*Important!*

Failure to observe the warning could result in injury or damage to the appliance.



*Danger of burns!*

Failure to observe the warning could result in scalds.



*Please note:*

This symbol identifies important advice or information for the user.

### Letters in brackets

The letters in brackets refer to the legend in the Description of the Appliance on page 3.

### Troubleshooting and repairs

In the event of problems, first try and resolve them following the information given in the section "Displayed messages" on page 20 and "Troubleshooting" on page 21.

If this does not resolve the problem or you require further information, you should consult Customer Experience by calling the number given on the annexed "Customer Experience" sheet.

If your country is not among those listed on the sheet, call the number given in the guarantee.

If repairs are required, contact De'Longhi Customer Experience only.

Contact details are given in the guarantee certificate provided with the appliance.

## DESCRIPTION

### Description of the appliance







(page 3 - A )

- A1. Beans container lid
- A2. Top lid
- A3. Grinding adjustment dial
- A4. Beans container
- A5. Pre-ground coffee funnel lid with pressure lock
- A6. Pre-ground coffee funnel
- A7. Main switch
- A8. Socket for power cable connector
- A9. Infuser
- A10. Infuser door
- A11. Cup warmer shelf
- A12. Control panel
- A13. Coffee spout (adjustable height)
- A14. Hot water and steam nozzle
- A15. Condensate tray
- A16. Water tank lid
- A17. Water tank
- A18. Water filter (certain models only)
- A19. Cup tray
- A20. Drip tray water level indicator
- A21. Drip tray
- A22. Coffee grounds container

### Description of the control panel

(page 2 - B )

*A number of buttons on the panel have a double function. This is indicated in brackets in the description.*

- B1.  button: turns the appliance on and off
- B2.  button: to select the coffee quantity
- B3. **MENU/ESC** button to access the menu or exit from the selected function
- B4. Display: guides the user in using the appliance.
- B5.  / **OK** button: to deliver hot water (*When in the settings menu, press to confirm the selection*)
- B6.  button: to make 1 cup of coffee with the settings displayed
- B7.  aroma selection button: to select the coffee taste
- B8. **CAFFELATTE** button: to deliver a caffelatte
- B9. **CAPPUCCINO** button: to deliver a cappuccino (*When in the settings menu, press to scroll backwards*)
- B10. **LATTE MACCHIATO** button: to deliver a macchiato
- B11. **MILK** button: to deliver a cup of milk (*When in the settings menu, press to scroll forwards*)
- B12:  button: to deliver steam
- B13.  button: to make 2 cups of coffee with the settings displayed

## Description of the milk container

(page 3 - C )

- C1. Milk container lid
- C2. Froth adjustment dial
- C3. CLEAN button
- C4. Frothed milk spout (adjustable)
- C5. Milk carafe
- C6. Milk intake tube

## Description of the accessories

(page 2 - D )

- D1. Pre-ground coffee measure
- D2. Cleaning brush
- A18. Water filter (certain models only)
- D3. Cappuccino maker/hot water spout
- D4. Power cable
- D5. "Total Hardness Test" indicator paper
- D6. Descaler

## PRELIMINARY CHECKS

---

### Checking the appliance

After removing the packaging, make sure the product is complete and undamaged and that all accessories are present. Do not use the appliance if it is visibly damaged.

Contact De'Longhi Customer Experience.

### Installing the appliance



*Important!*

When installing the appliance, respect the following safety warnings:

- The appliance gives off heat.  
After positioning the appliance on the worktop, leave a space of at least 1.18 in / 3 cm between the surfaces of the appliance and the side and rear walls and at least 5.9 in/ 15 cm above the coffee maker.
- Water penetrating the coffee maker could cause damage.  
Do not place the appliance near taps or sinks.
- The appliance could be damaged if the water it contains freezes.  
Do not install the appliance in a room where the temperature could drop below freezing point.
- Arrange the power cable in such a way that it cannot be damaged by sharp edges or contact with hot surfaces (e.g. electric hot plates).

### Connecting the appliance



*Important!*

Check that the mains power supply voltage corresponds to the value indicated on the rating plate on the bottom of the

appliance.

If the power socket does not match the plug on the appliance, have the socket replaced with a suitable type by a qualified professional.

### Using the appliance for the first time



*Please note!*

- Coffee has been used to factory test the appliance and it is therefore completely normal for there to be traces of coffee in the mill.

The machine is, however, guaranteed to be new.

- You should customise water hardness as soon as possible following the instructions in the section "Setting the water hardness" on page 18.

1. Insert the power cable connector into the socket at the back of the appliance and connect the appliance to the mains electricity supply (fig. 1). Make sure the main switch at the back of the appliance is pressed (fig. 2).

You must first choose the language (the languages scroll through at intervals of about 3 seconds).

2. When "English" appears, press and hold the  /OK button (fig. 3) for a few seconds until "English set" is displayed.

Follow the instructions displayed by the appliance:

3. "FILL TANK!": remove the water tank (fig. 4), fill to the MAX line with fresh water then replace in the appliance.
4. "INSERT WATER SPOUT!": Check that the hot water spout is inserted on the nozzle and place a container with a minimum capacity of 3.4 oz / 100 ml underneath (fig. 6).
5. "Hot water Press OK?" is displayed;
6. Press the  /OK button to confirm (fig. 3). The appliance delivers water from the spout then goes off automatically.

The coffee maker is now ready for normal use.



*Please note!*

- When using the appliance for the first time, you need to make 4-5 cups of coffee or 4-5 cappuccinos before the appliance starts to give satisfactory results.
- To help reduce the buildup of limescale in the appliance and soften the water taste, we recommend installing a water filter as described in the section "WATER FILTER". If your model is not provided with a filter, you can request one from De'Longhi Customer Experience.

## TURNING THE APPLIANCE ON



*Please note!*

Before turning the appliance on, make sure the main switch on the back of the appliance is pressed (fig. 2).

Each time the appliance is turned on, it performs an automatic preheat and rinse cycle which cannot be interrupted.

The appliance is ready for use only after completion of this cycle.



*Danger of burns!*

During rinsing, a little hot water comes out of the coffee spouts and is collected in the drip tray underneath.

Avoid contact with splashes of water.

- To turn the appliance on, press the  button (fig. 7).  
The message "Heating up Please wait" is displayed.

After heating, the message "Rinsing" is displayed. As well as heating the boiler, the appliance also heats the internal circuits by circulating hot water.

The appliance has reached the required temperature when a message is displayed indicating the coffee taste and quantity.

## TURNING THE APPLIANCE OFF

Each time the appliance is turned off, it performs an automatic rinse cycle which cannot be interrupted.



*Danger of burns!*

During rinsing, a little hot water flows from the coffee spouts. Avoid contact with splashes of water.

To turn the appliance off, press the  button (fig. 7).

The appliance performs a rinse cycle, then the message "Turning off underway Please wait" is displayed and the appliance goes off.



*Please note!*

If the appliance is not used for an extended period, switch off the machine at the main switch (fig. 2).



*Important!*

To avoid damaging the appliance, never switch the appliance off at the main switch before it has been turned off using the



button.



## MENU SETTINGS

When you access the programming menu by pressing the **MENU/ESC** button, the following menu items are available:

### Rinsing

Use this function to deliver hot water from the spout to heat the internal circuit and make the coffee delivered hotter.

To enable the function, proceed as follows:



1. Press the **MENU/ESC** button to enter the menu;
2. Press the **MILK** or **CAPPUCCINO** button (fig. 8) until "Rinsing" is displayed;
3. Press the /OK button. The message "Confirm?" is displayed;
3. Press the /OK button (fig. 3). Hot water flows out of the spout, heating the internal circuit and making the coffee delivered hotter.

### Descalc

For instructions on descaling, see page 17.

### Adjust time

To adjust the time on the display, proceed as follows:



1. Press the **MENU/ESC** button to enter the menu;
2. Press the **MILK** or **CAPPUCCINO** button (fig. 8) until "Adjust time" is displayed;
3. Press the /OK button (fig. 3);
4. Press the **MILK** or **CAPPUCCINO** button (fig. 8) to change the hours;
5. Press the /OK button to confirm;
6. Press the **MILK** or **CAPPUCCINO** button (fig. 8) to change the minutes;
7. Press the /OK button to confirm.

This sets the time. Press the **MENU/ESC** button to exit the menu.

### Auto-off

The auto-off time can be changed so that the appliance switches off after 15 or 30 minutes, or after 1, 2 or 3 hours.

To re-programme Auto-off, proceed as follows:

1. Press the **MENU/ESC** button to enter the menu;
2. Press the **MILK** or **CAPPUCCINO** button (fig. 8) until "Auto-off" is displayed;
3. Press the /OK button;
4. Press the **MILK** or **CAPPUCCINO** button (fig. 8) until the desired operation time is displayed (15 or 30 minutes, or 1, 2 or 3 hours);
5. Press the /OK button to confirm;
6. Press the **MENU/ESC** button to exit the menu.

Auto-off is programmed.

### Auto-start





You can set the auto-start time in order to have the appliance ready at a certain time (for example in the morning) so you can make coffee immediately.



*Please note!*



To enable this function, the time must already have been set correctly.

To enable Auto-on, proceed as follows:

1. Press the **MENU/ESC** button to enter the menu;
2. Press the **MILK** or **CAPPUCCINO** button (fig. 8) until "Auto-start" is displayed;
3. Press the /OK button. "Enable?" is displayed;
4. Press the /OK button to confirm;
5. Press the **MILK** or **CAPPUCCINO** button to choose the hours;
6. Press the /OK button to confirm;
7. Press the **MILK** or **CAPPUCCINO** button (fig. 8) to change the minutes;
8. Press the /OK button to confirm;
9. Press the **MENU/ESC** button to exit the menu.

Once the time has been confirmed, enabling of auto-start is indicated by the  symbol displayed alongside the time and under the Auto-start item in the menu.

To disable the function:

1. Select auto-start from the menu;
2. Press the /OK button. "Disable?" is displayed;
3. Press the /OK button to confirm.

The  symbol is no longer displayed.

### Setting the temperature

To modify the temperature of the water used to make the coffee, proceed as follows:



1. Press the **MENU/ESC** button to enter the menu;
2. Press the **MILK** or **CAPPUCCINO** button (fig. 8) until "Set temperature" is displayed;
3. Press the /OK button;
4. Press the **MILK** or **CAPPUCCINO** button until the required temperature (●= low, ●●●●= high) is displayed;
5. Press the /OK button to confirm;
6. Press the **MENU/ESC** button to exit the menu.

### Energy Saving

Use this function to enable or disable energy saving mode.

When enabled, the function reduces energy consumption in compliance with European regulations.

To disable (or enable) "energy saving" mode, proceed as follows:

1. Press the **MENU/ESC** button to enter the menu;
2. Press the **MILK** or **CAPPUCCINO** button (fig. 8) until "Energy saving" is displayed;
3. Press the /OK button. "Disable?" is displayed (or "Enable?" if the function has been disabled);
4. Press the /OK button to disable (or enable) energy saving mode;
5. Then press the **MENU/ESC** button to exit the menu.

When the function is enabled, if the machine is not used for

about 1 minute, "Energy Saving" is displayed.





*Please note!*

When in energy saving mode, a few seconds may elapse before the first drink with milk is delivered as the appliance must heat up again.

### Cup warmer

This function enables or disables the cup warmer.

Proceed as follows:

1. Press the **MENU/ESC** button to enter the menu;
2. Press the **MILK** or **CAPPUCCINO** button (fig. 8) until "Cup warmer" is displayed;
3. Press the /OK button. "Disable?" is displayed (or "Enable?" if the function has been disabled);
4. Press the /OK button to disable (or enable) the function.
5. Press the **MENU/ESC** button to exit the menu.



Warming the cups keeps the coffee hot.

### Setting water hardness

For instructions on setting water hardness, see page 17.

### Setting the language

To change the language for the display, proceed as follows:

1. Press the **MENU/ESC** button to enter the menu;
2. Press the **MILK** or **CAPPUCCINO** button (fig. 8) until "Set language" is displayed;
3. Press the /OK button;
4. Press the **MILK** or **CAPPUCCINO** button until the required language is displayed;
5. Press the /OK button to confirm;
6. Press the **MENU/ESC** button to exit the menu.

### Install filter

For instructions on how to install the filter, see the section "Installing the filter" on page 18.

### Replacing the filter

For instructions on how to replace the filter, see the section "Replacing the filter" on page 19.

### Beep

This enables or disables the beep emitted by the machine each time the buttons are pressed or an accessory is inserted/removed. The beep is enabled by default.

To disable or re-enable the beep, proceed as follows:

1. Press the **MENU/ESC** button to enter the menu;
2. Press the **MILK** or **CAPPUCCINO** button (fig. 8) until "Beep" is displayed;
3. Press the /OK button. "Disable?" or "Enable?" is

displayed;

- Press the /OK button to enable or disable the beep;
- Press the **MENU/ESC** button to exit the menu.

### Cup lighting

This function enables or disables the cup lighting. The lighting is enabled by default.

The lights come on each time coffee and drinks with milk are made and during each rinse cycle.

To disable or re-enable this function, proceed as follows:

- Press the **MENU/ESC** button to enter the menu;
- Press the **MILK** or **CAPPUCCINO** button (fig. 8) until “Cup lighting” is displayed.
- Press the /OK button. “Disable?” or “Enable?” is displayed;
- Press the /OK button to enable or disable the cup lighting;
- Press the **MENU/ESC** button to exit the menu.

### Default values (reset)

This resets all menu settings and programmed quantities back to the default values (with the exception of the language which remains as previously set).

To reset the default values, proceed as follows:

- Press the **MENU/ESC** button to enter the menu;
- Press the **MILK** or **CAPPUCCINO** button (fig. 8) until “Default values” is displayed;
- Press the /OK button
- The message “Confirm?” is displayed.
- Press the /OK button to confirm and exit.

### Statistics function

This displays statistics relating to the machine.

To display, proceed as follows:

- Press the **MENU/ESC** button to enter the menu;
- Press the **MILK** or **CAPPUCCINO** button (fig. 8) until “Statistics” is displayed;
- Press the /OK button;
- Press the **MILK** or **CAPPUCCINO** button (fig. 8) to verify:
  - how many coffees have been made;
  - how many times the machine has been descaled;
  - the total number of liters of water delivered;
  - how many times the water filter has been replaced;
  - the total number of drinks made with milk.
- Press the **MENU/ESC** button twice to exit the menu.

## MAKING COFFEE

### Selecting the coffee taste

The appliance is set by default to make coffee with a standard taste.

You can also choose one of these tastes:

Extra-mild taste  
Mild taste  
Standard taste  
Strong taste  
Extra-strong taste

To change the taste, press the button (fig. 9) repeatedly until the required taste is displayed.

### Selecting the quantity of coffee in the cup

The appliance is set by default to make a standard quantity of coffee.

To select the quantity of coffee, press the button (fig. 10) until the message corresponding to the required quantity of coffee is displayed:

Coffee selected	Quantity in cup (fl oz./ ml)
MY COFFEE	Programmable: from ≈0.68/20 to ≈6/180
ESPRESSO	≈1.35/40
STANDARD	≈2/60
LONG	≈3/90
EXTRA LONG	≈4/120

### Customising the “my coffee” quantity

The appliance is set by default to automatically deliver 1 fl oz./ 30 ml of “my coffee”.

To modify this quantity, proceed as follows:

- Place a cup under the coffee spouts (fig. 14).
- Press the button (fig. 10) until “MY COFFEE” is displayed.
- Keep the button (fig. 11) pressed until the message “1 MY COFFEE Program quantity” is displayed and coffee delivery begins. Release the button.
- As soon as the coffee in the cup reaches the required level, press the button (fig. 11) again.

The quantity of coffee in the cup has now been programmed.

### Adjusting the coffee mill

The coffee mill is preset in the factory to make coffee correctly and should not require adjusting initially.

However, if after making the first few coffees you find that the coffee is too thin and not creamy enough or that delivery is too slow (a drop at a time), this can be corrected by adjusting the grinding adjustment dial (fig. 12).

Please note!

The grinding adjustment dial must only be turned when the

coffee mill is in operation.

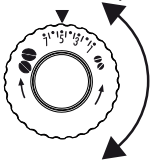

If the coffee is delivered too slowly or not at all, turn one click clockwise towards "7".

For fuller bodied creamier coffee on the other hand, turn one click anticlockwise towards "1" (do not turn more than one

click at a time otherwise the coffee could be delivered a drop at a time).

These adjustments will only be evident after at least 2 cups of coffee have been delivered.

If this adjustment does not obtain the desired result, turn the dial another click.

### Tips for a hotter coffee

For a hotter coffee, before delivery you are recommended to:



- perform a rinse cycle by selecting the "Rinsing" function in the settings menu (page 10)
- warm the cups with hot water (using the hot water function);
- increase the coffee temperature in the settings menu (page 10).

### Making coffee using coffee beans







**Important!**

Do not use caramelized or candied coffee beans as they could stick to the coffee mill and make it unusable.

1. Place coffee beans in the coffee bean container (fig. 13).
2. Place under the coffee dispensing spouts, either:
  - 1 cup if you want one coffee (fig. 14);
  - 2 cups if you want 2 coffees.
3. Lower the spouts as near as possible to the cup. This makes a creamier coffee (fig. 15).
4. Press the button corresponding to the number of coffees required (1 cup  or 2 cups  , figs. 11 and 16).
5. Preparation begins. The amount of coffee selected is displayed together with a progress bar which gradually fills as preparation progresses.



**Please note:**

- While the coffee maker is making coffee, delivery can be interrupted at any moment by pressing one of the two coffee buttons (  or  ).
- At the end of delivery, to increase the quantity of coffee in the cup, just press (within 3 seconds) one of the coffee buttons (  or  ).

Once the coffee has been made, the appliance is ready to use again.



**Please note!**

- Various alarm messages could be displayed while using the machine (fill tank, empty grounds container, etc.). Their meaning is explained in the section "Displayed messages" (page 20).
- For hotter coffee, see the section "Tips for a hotter coffee" (page 12).
- If the coffee is delivered a drop at a time, too weak and not creamy enough or too cold, read the tips in the "Troubleshooting" section on page 21.

### Making coffee using pre-ground coffee





**Important!**

- Never add pre-ground coffee when the machine is off or it could spread through the inside of the machine and dirty it.  
This could damage the appliance.
- Never use more than 1 level measure or it could dirty the inside of the coffee maker or block the funnel.



**Please note!**

If you use pre-ground coffee, you can only make one cup of coffee at a time.

1. Press the  button (fig. 9) until "Pre-ground" is displayed.
2. Open the beans container lid; then open the pre-ground coffee funnel lid by pushing on PUSH and, once released, open the lid.
3. Make sure the funnel is not blocked, then add one level measure of pre-ground coffee (fig. 17).
4. Place a cup under the coffee spouts.
5. Press the 1 cup coffee button  (fig. 11).
6. Preparation begins. The amount of coffee selected is displayed together with a progress bar which gradually fills as preparation progresses.



**Please note!**

If "Energy saving" mode is enabled, you may have to wait a few seconds before the first coffee is delivered.

### MAKING DRINKS WITH MILK



**Please note!**

- To avoid producing milk with poor froth or large bubbles, always clean the milk container lid and hot water nozzle as described in the section "Cleaning the milk container" on pages 14 and 17.

## Filling and attaching the milk container

1. Remove the lid (fig. 18);
2. Fill the milk container with a sufficient quantity of milk, not exceeding the MAX level marked on the container (fig. 19). Each mark on the side of the container corresponds to 3.4 oz / 100 ml of milk.





*Please note!*

- For a denser more even froth, you should use skimmed or partially skimmed milk at refrigerator temperature (about 5°C).
  - If “Energy Saving” mode is enabled, you may have to wait a few seconds before the first drink is delivered.
3. Make sure the milk intake tube is correctly inserted in the bottom of the milk container lid (fig. 20).
  4. Place the lid back on the milk container.
  5. Remove the hot water spout from the nozzle.
  6. Attach the container to the nozzle and push as far as it will go (fig. 21). The machine emits a beep (if the beep function is enabled).
  7. Place a sufficiently large cup under the coffee and frothed milk spouts. Adjust the length of the milk spout. To move it nearer the cup, simply pull it downwards (fig. 22).
  8. Follow the instructions below for each function.

## Adjusting the amount of froth

Turn the froth adjustment dial on the milk container lid to adjust the amount of froth on the milk delivered while making drinks with milk.

Dial position	Description	Recommended for...
1 	No froth	CAFFELATTE / MILK (hot milk)
2 	Min. froth	MACCHIATO
3 	Max. froth	C A P P U C C I N O / M I L K (FROTHED MILK)

## Making drinks with milk automatically

The CAFFELATTE, CAPPUCINO, MACCHIATO and MILK buttons on the control panel enable these drinks to be prepared automatically.

Proceed as follows:

1. Fill the milk container and attach it as described above.
2. Turn the froth adjustment dial on the milk container lid to the position corresponding to the required froth.
3. Press the button corresponding to the required drink.

The name of the drink selected is displayed together with a progress bar which gradually fills as preparation progresses.

4. After a few seconds, frothed milk is delivered from the milk spout into the cup below. For drinks with coffee, the machine automatically makes the coffee after delivering the milk.



*Please note!*

- If during delivery you want to stop preparation, press the corresponding button.
- At the end of delivery, to increase the quantity of milk or coffee in the cup, just press (within 3 seconds) the button corresponding to the drink being made.
- Do not leave the milk container out of the refrigerator for long periods. The warmer the milk (5°C is ideal), the poorer the quality of froth produced.

## Cleaning the milk frother with the CLEAN button

“Press CLEAN “ flashes on the display each time you use a milk function.

To eliminate all milk residues, proceed as follows:

1. Leave the milk container in the machine (you do not need to empty it);
2. Place a cup or other recipient under the frothed milk spout.
3. Press the CLEAN button (fig. 23) and keep pressing until the progress bar which appears on the display together with the message “Cleaning...” is complete.



*Please note!*

- If you are making a number of milk based drinks one after the other, you do not need to clean by pressing the CLEAN button each time you make a cappuccino. Just press it once after making the last cup (the appliance continues functioning even if the CLEAN button is not pressed).



*Important!*

After use, always clean the hot water/steam nozzle and the milk container as described on page 14.

## Programming the quantity of coffee and milk in the cup for the CAFFELATTE, CAPPUCINO, MACCHIATO and MILK buttons.

The appliance is set by default to automatically deliver standard quantities.

To change these quantities, proceed as follows:

1. Place a cup under the coffee and milk spouts.
2. Press and hold one of the function buttons until the message “Milk for ... Program Quantity” is displayed.

3. Release the button.  
The appliance starts delivering milk.
4. Once the required quantity of milk has been delivered into the cup, press the button again.
5. The appliance stops delivering milk and (if required for the drink being prepared) after a few seconds the coffee is delivered into the cup. "Coffee for . . . Program Quantity" is displayed.
6. Once the required quantity of coffee has been delivered into the cup, press the button.  
Coffee delivery stops.

The machine is now reprogrammed with the new quantities of milk and coffee.

## DELIVERING HOT WATER AND STEAM



**Important! Danger of burns.**

Never leave the machine unsupervised while delivering hot water or steam.

The spout becomes hot during delivery. Hold by the handle only.



**Please note!**

If "Energy Saving" mode is enabled, you may have to wait a few seconds before the hot water or steam is delivered.

### Delivering hot water

1. Make sure the hot water spout is attached correctly (fig. 6).
2. Place a container under the spout (as close as possible to avoid splashes).
3. Press the button (fig. 3).  
"Hot water" is displayed, together with a progress bar which fills gradually as preparation proceeds.
4. The machine delivers 8.5 oz / 250 ml of hot water, then delivery stops automatically.  
To interrupt delivery of hot water manually, press the button again.

### Change the quantity of water delivered automatically.

The machine is set by default to automatically deliver 8.5 oz / 250 ml of hot water.

To modify these quantities, proceed as follows:

1. Position a container under the spout.
2. Press the button again until "Hot water Program quantity" is displayed, then release the button.
3. When the hot water in the cup reaches the required level, press the button again.

The machine is now reprogrammed with the new quantity.

### Delivering steam

1. Make sure the hot water spout is attached correctly (fig. 6).
2. Fill a container with the liquid to be heated/frothed and immerse the spout/cappuccino maker in the liquid.
3. Press the button. After a few seconds, the steam to heat the liquid comes out of the cappuccino maker;
4. When the required temperature is obtained, interrupt steam delivery by pressing the button again.  
(You should not discharge steam for more than 3 minutes at a time).



**Important!**

Always stop steam delivery before extracting the container containing the liquid to avoid burns from splashes.

### Tips for using steam to froth milk

- When choosing the size of the container, bear in mind that the liquid doubles or triples in volume.
- For a richer denser froth, use skimmed or partially skimmed milk at refrigerator temperature (about 5°C).
- For a creamier froth, rotate the container with slow movements in an upward direction.
- To avoid milk with poor froth or large bubbles, always clean the spout as described in the following section.

### Cleaning the spout after use

Always clean the spout after use to avoid the build-up of milk residues and prevent the spout from clogging.

1. Place a container under the cappuccino maker and press the button to deliver a little water (fig. 3).  
Stop the flow of water by pressing the button again.
2. Wait a few minutes for the cappuccino maker to cool down, then extract the hot water spout.  
Hold the spout with one hand by pressing the button and with the other, turn the cappuccino maker anticlockwise (fig. 24) and pull it downwards to remove it.
3. Also remove the steam nozzle by pulling it downwards (fig. 25).
4. Check the hole shown by the arrow in fig. 25 is not blocked. If necessary, clean with a pin.
5. Wash all parts of the cappuccino maker thoroughly with a sponge and warm water.
6. Reinsert the nozzle and replace the cappuccino maker on the nozzle, turning it and pushing it upwards until it is attached.



## CLEANING



*Important!*

- Do not use solvents, abrasive detergents or alcohol to clean the coffee maker.  
With De'Longhi bean to cup coffee makers, you need not use chemical products to clean the machine.
- None of the components can be washed in a dishwasher apart from the milk container (C).
- Do not use metal objects to remove encrustations or coffee deposits as they could scratch metal or plastic surfaces.

### Cleaning the coffee grounds container

When "EMPTY GROUNDS CONTAINER" is displayed, the grounds container must be emptied and cleaned.

Until the grounds container has been cleaned, the appliance continues to display the message and coffee cannot be made.



*Important! Danger of burns*

If you make a number of cappuccinos one after the other, the metal cup tray becomes hot.

Wait for it to cool down before touching it and handle it from the front only.

To clean (with the machine on):

- Remove the drip tray (fig. 26), empty and clean.
- Empty the grounds container and clean thoroughly to remove all residues left on the bottom. This can be done with the spatula on the brush provided.
- Check the condensate tray (red) and empty if necessary.



*Important!*

When removing the drip tray, the grounds container must be emptied, even if it contains few grounds.

If this is not done, when you make the next coffees, the grounds container may fill up more than expected and clog the machine.

### Cleaning the drip tray and condensate tray



*Important!*

The drip tray is fitted with a level indicator (red) showing the level of water it contains (fig. 27).

Before the indicator protrudes from the cup tray, the drip tray must be emptied and cleaned, otherwise the water may overflow the edge and damage the appliance, the surface it rests on or the surrounding area.

To remove the drip tray:

1. Remove the drip tray and the grounds container (fig. 26);
2. Empty the drip tray and grounds container and wash them;

3. Check the red condensate tray and empty if necessary.
4. Replace the drip tray and grounds container.

### Cleaning the inside of the coffee maker



*Danger of electric shock!*

Before cleaning internal parts, the machine must be turned off (see "Turning off") and unplugged from the mains power supply.

Never immerse the coffee maker in water.

1. Check regularly (about once a month) that the inside of the appliance (accessible after removing the drip tray) is not dirty. If necessary, remove coffee deposits with the brush provided or a sponge.
2. Remove the residues with a vacuum cleaner (fig. 28).

### Cleaning the water tank

1. Clean the water tank (A17) regularly (about once a month and whenever you replace the water softener filter (if provided) with a damp cloth and a little mild washing up liquid.
2. Remove the filter (if present) and rinse with running water.
3. Replace the filter (if provided), fill the tank with fresh water and replace the tank.

### Cleaning the coffee spouts

1. Regularly clean the coffee spouts with a sponge or cloth (fig. 29A).
2. Check the holes in the coffee spout are not blocked. If necessary, remove coffee deposits with a toothpick (fig. 29B).

### Cleaning the pre-ground coffee funnel

Check regularly (about once a month ) that the pre-ground coffee funnel (A6) is not blocked.

If necessary, remove coffee deposits with the brush (D2) supplied.

### Cleaning the infuser

The infuser (A9) must be cleaned at least once a month.



*Important!*

The infuser may not be extracted when the machine is on.



1. Make sure the machine is correctly turned off (see "Turning the appliance off" on page 9).
2. Remove the water tank.
3. Open the infuser door (fig. 30) on the right side.
4. Press the two red release buttons inwards and at the same time pull the infuser outwards (fig. 31).
5. Soak the infuser in water for about 5 minutes, then rinse under the tap.

**!** *Important!*

RINSE WITH WATER ONLY

NO WASHING UP LIQUID - NO DISH WASHER

Clean the infuser without using washing up liquid as it could be damaged

- Use the brush   any coffee residues left in the infuser housing, visible through the infuser door.
- After cleaning, replace the infuser by sliding it onto the internal support; then push the PUSH symbol fully in until it clicks into place.

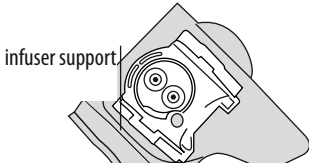

**i** *Please note!*

If the infuser is difficult to insert, before insertion, adapt it to the right size by pressing the two levers shown in the figure.

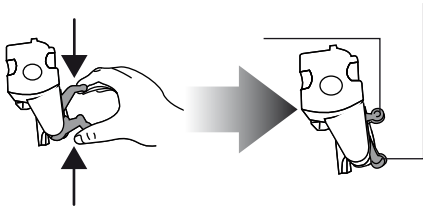

- Once inserted, make sure the two red buttons have snapped out.

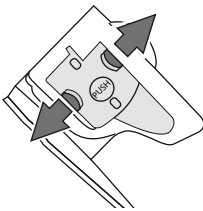

- Close the infuser door.
- Replace the water tank.

**Cleaning the milk container**

Clean the milk container as described below each time you prepare milk:

- Remove the lid.
- Remove the milk spout and intake tube.

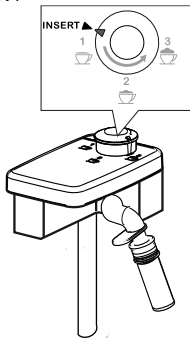

- Turn the froth adjustment dial to the "INSERT" position (see figure) and pull it off upwards.
- Wash all the components thoroughly with hot water and mild washing-up liquid.

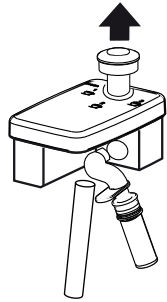

All components are dishwasher safe, placing them in the top basket of the dishwasher.

Make sure there are no milk residues in the hollow and groove under the dial (see figure alongside). If necessary, scrape the groove with a toothpick.

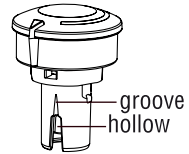

- Rinse the inside of the froth adjustment dial under running water (see figure)
- Check that the intake tube and spout are not clogged with milk residues.
- Replace the dial (lining up the arrow with the word "INSERT", the spout and the milk intake tube).
- Place the lid back on the milk container.

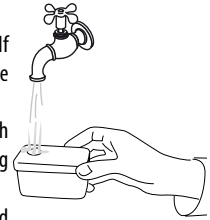

**Cleaning the hot water/steam nozzle**

Each time you prepare milk, clean the nozzle with a sponge to remove milk residues from the gaskets (see figure alongside).

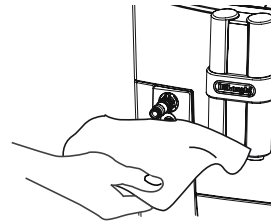

**DESCALE**

Descal the machine when the message "DESCALE" flashes on the display.

**!** *Important!*



- Descaler contains acids which may irritate the skin and eyes.

It is vital to respect the manufacturer's safety warnings given on the descaler pack and the warnings relating to the procedure to follow in the event of contact with the skin and eyes.

Use De'Longhi descaler only.

Under no circumstances should you use sulphamic or acetic based descalers. Their use invalidates the guarantee.

Failure to descale the appliance as described also invalidates the guarantee.

1. Turn the machine on.
2. Press the **MENU/ESC** button to enter the menu.
3. Press the **MILK** or **CAPPUCCINO** button until "Descaling" is displayed.
4. Select by pressing the /OK button: "Descaling Confirm?" is displayed. Press /OK again to enable the function.
5. The message "Add descaler Confirm?" is displayed alternating with "EMPTY THE DRIP TRAY"
6. Completely empty the water tank (A17) and remove the water filter (if present). Empty the drip tray (fig. 26) and grounds container, then put back in the appliance.
7. Pour the descaler into the tank up to the level **A** (corresponding to a 3.4 oz / 100 ml pack) marked on the side of the tank (fig. 32), then add water (one liter) up to level **B** (fig. 32). replace the water tank.
8. Place an empty container with a minimum capacity of 1.5 liters under the hot water spout (fig. 6).



**Important! Danger of burns**

Hot water containing acid flows from the spout.

Avoid contact with splashes of water.

9. Press the /OK button to confirm introduction of the solution.

The message "Descaling underway" is displayed.

The descaling programme starts and the descaler liquid comes out of the water spout.



The descale programme automatically performs a series of rinses and pauses to remove limescale deposits from inside the machine.

After about 30 minutes, the message "FILL TANK" is displayed.

7. The appliance is now ready for rinsing through with clean water.

Remove the water tank, empty, rinse under running water, fill with clean water and replace.

"Rinsing, Press OK" is displayed.

8. Empty the container used to collect the descaler solution and replace it empty under the hot water spout.
9. Press the /OK button to start rinsing.  
Hot water flows out of the spout and the message "Rinsing" is displayed.
10. When the water tank is completely empty, " Rinsing Complete Confirm?" is displayed.
11. Press the /OK button.
12. Insert the filter (if present) in the tank (see section "Installing the filter" on page 18), fill the water tank again and the appliance is ready for use.

## SETTING THE WATER HARDNESS

The DESCALE message is displayed after a period of time according to water hardness.

The machine is factory set for a hardness value of 4.

The machine can also be programmed according to the hardness of the mains water in the various regions so that the machine needs to be descaled less often.

### Measuring water hardness

1. Remove the "total hardness test" indicator paper attached to this manual from its pack.
2. Immerse the paper completely in a glass of water for one second.
3. Remove the paper from the water and shake lightly.  
After about a minute, 1, 2, 3, or 4 red squares form, depending on the hardness of the water. each square corresponds to one level.

soft water ● 

slightly hard water ●● 

hard water ●●● 

very hard water ●●●● 

### Set water hardness

1. Press the **MENU/ESC** button to enter the menu.
2. Press the **MILK** or **CAPPUCCINO** button to select "Water Hardness".
3. Confirm the selection by pressing the /OK button.
4. Press the **MILK** or **CAPPUCCINO** button and set the hardness shown by the indicator paper (see previous section).
5. Press the /OK button to confirm the setting.
6. Press the **MENU/ESC** button to exit the menu.

The machine is now reprogrammed with the new water hardness setting

## WATER FILTER (CERTAIN MODELS ONLY)

Certain models are fitted with a water softener filter. If this is not the case with your model, you are recommended to purchase one from De'Longhi Customer Service.

To use the filter correctly, follow the instructions below.

### Installing the filter

1. Remove the filter from the packaging.
2. Turn the date indicator disk (see fig. 33) until the next 2 months of use are displayed.

**i** Please note

The filter lasts about two months if the appliance is used normally. If the coffee maker is left unused with the filter installed, it will last a maximum of three weeks.

3. Remove the tank from the appliance and fill with water.
4. Insert the filter in the water tank and immerse it completely for ten or so seconds, sloping it to enable the air bubbles to escape (fig. 34).
5. Insert the filter in the filter housing (fig. 35A) and press as far as it will go.
6. Close the tank with the lid (fig. 35B), then replace the tank in the machine.

When you install the filter, you must notify the appliance of its presence.

7. Press the **MENU/ESC** button to enter the menu;

8. Press the **MILK** or **CAPPUCCINO** button (fig. 8) until "Install filter" is displayed;

9. Press the  $\Delta$ /OK button;

10. The message "Enable?" is displayed.

11. Press the  $\Delta$ /OK button to confirm the selection. "Hot water Confirm?" is displayed.

12. Position a container with a minimum capacity of 3.4 oz / 100 ml under the hot water spout.

13. Press the  $\Delta$ /OK button to confirm the selection. The appliance begins delivering hot water and the message "Please wait " is displayed.

14. After delivery, the appliance returns automatically to the "Ready for coffee" position.

The new filter is active. You can now use the coffee maker.

### Replacing the filter

When "REPLACE FILTER" is displayed, after two months (see date indicator) or when

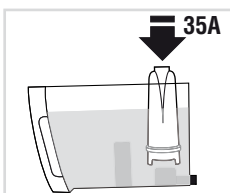
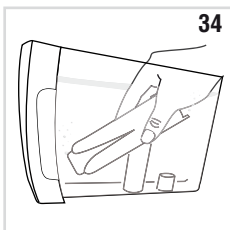
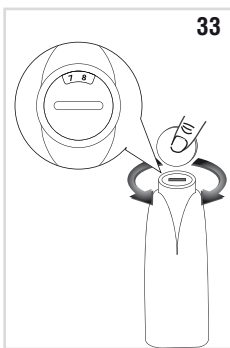

the appliance has not been used for 3 weeks, you should replace the filter:

1. Remove the exhausted filter;
2. Remove the new filter from the packaging.
3. Turn the date indicator disk (see fig. 33) until the next 2 months of use are displayed (the filter lasts about two months);
4. Refill the tank;
5. Insert the filter in the water tank and immerse it completely, tilting it to enable the air bubbles to escape (fig. 34);
6. Place the filter in the filter housing (fig. 35aa) and press as far as it will go. close the tank with the lid (fig. 35b), then replace the tank in the machine;
7. Position a container with a minimum capacity of 3.4 oz / 100 ml under the hot water spout.
8. Press the **MENU/ESC** button to enter the menu;
9. Press the **MILK** or **CAPPUCCINO** button until "Reset filter " is displayed.
10. Press the  $\Delta$ /OK button;
11. The message "Confirm?" is displayed.
12. Press the  $\Delta$ /OK button to confirm the selection;
13. "Hot water, Press OK" is displayed.
14. Press the  $\Delta$ /OK button to confirm the selection. the appliance begins delivering hot water and the message "Please wait " is displayed.
15. After delivery, the appliance returns automatically to the "ready for coffee" position.

The new filter is now active and you can use the coffee maker.

### Removing the filter

If you want to continue using the appliance without a filter, you must remove it and notify the appliance of its removal as follows:

1. Extract the tank and exhausted filter;
2. Press the **MENU/ESC** button to enter the menu;
3. Press the **MILK** or **CAPPUCCINO** button (fig. 8) until "Install filter Enabled" is displayed;
4. Press the  $\Delta$ /OK button
5. "Disable?" is displayed;
6. Press the  $\Delta$ /OK button to confirm and the **MENU/ESC** button to exit the menu.

### TECHNICAL SPECIFICATION

Voltage:	120V~60 Hz
Absorbed power:	1250W
Pressure:	15 bar
Water tank capacity:	67.62 fl. oz. / 2.0 liters max.
Size Lxhxd:	9.3x13.8x17.5 in / 238x350x445 mm
Cable length:	2,92 ft / 1.80 m
Weight:	260 lb / 11.8 kg
Beans container capacity:	8.82 oz / 250 g max.



## DISPLAYED MESSAGES

DISPLAYED MESSAGE	POSSIBLE CAUSE	REMEDY
FILL TANK	Insufficient water in the tank.	Fill the tank with water and/or insert it correctly, pushing it as far as it will go until it clicks into place.
EMPTY GROUNDS CONTAINER	The grounds container (A22) is full.	Empty the grounds container and drip tray, clean and replace (fig. 26). Important: when removing the drip tray, the grounds container must be emptied, even if it is not completely full. If this is not done, when you make the next coffees, the grounds container may fill up more than expected and clog the machine.
GROUND TOO FINE ADJUST MILL <i>alternating with</i> Insert water spout and press OK	The grinding is too fine and the coffee is delivered too slowly or not at all.	Repeat coffee delivery and turn the grinding adjustment dial (fig. 12) one click clockwise towards "7" while the coffee mill is in operation. If after making at least 2 coffees delivery is still too slow, repeat the correction procedure, turning the grinding adjustment dial another click (see the section "adjusting the coffee mill" on page 12).
INSERT GROUNDS CONTAINER	After cleaning, the grounds container has not been replaced	Remove the drip tray and insert the grounds container.
ADD PRE-GROUND COFFEE	The "pre-ground coffee" function has been selected without placing any pre-ground coffee in the funnel.	Place pre-ground coffee in the funnel (fig. 17) or deselect the "pre-ground" function.
DESCALE!	The machine must be descaled.	The descaling procedure described in the "descaling" section (page 17) needs to be performed as soon as possible.
LESS COFFEE	Too much coffee has been used.	Select a milder taste by pressing the  button (fig. 9) or reduce the quantity of pre-ground coffee, if using the pre-ground function.
FILL BEANS CONTAINER	The coffee beans have run out.	Fill the beans container (fig. 13).
	The pre-ground coffee funnel is clogged.	Clear the funnel with the help of a brush as described in the section "Cleaning the pre-ground coffee funnel".
INSERT INFUSER ASSEMBLY	The infuser has not been replaced after cleaning.	Insert the infuser as described in the section "cleaning the infuser".
INSERT TANK	The tank is not correctly in place.	Insert the tank correctly and press as far as it will go.
GENERAL ALARM	The inside of the appliance is very dirty.	Clean the inside of the appliance thoroughly, as described in the section "cleaning and maintenance". If the message is still displayed after cleaning, contact De'Longhi Customer Experience.
EMPTY CIRCUIT FILL CIRCUIT <i>alternating with</i> Hot water press OK	The water circuit is empty	Connect the water spout (D3) (fig.6), fill the water tank and press OK to deliver water from it, until it flows out normally.
REPLACE FILTER	The water filter is exhausted.	Replace the filter or remove it as described in the section "Water filter".
Press CLEAN	Milk has been delivered recently and the tubes inside the milk container must be cleaned.	Press the CLEAN button (fig. 23) and keep it pressed until the progress bar which appears on the display together with the message "Cleaning underway" is complete.
INSERT WATER SPOUT	The hot water spout is not inserted or is inserted incorrectly.	Insert water spout (D3) as far as it will go.
INSERT MILK CONTAINER	The milk container is not inserted correctly.	Insert the milk container as far as it will go (fig. 21).

## TROUBLESHOOTING

Below is a list of some of the possible malfunctions.

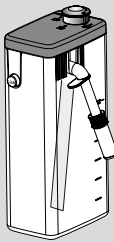
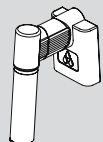
If the problem cannot be resolved as described, contact De'Longhi Customer Experience.

PROBLEM	POSSIBLE CAUSE	REMEDY
The coffee is not hot	The cups were not preheated.	<ul style="list-style-type: none"> <li>Enable the cup warmer, leave the cups at least 20 minutes to warm up.</li> <li>Warm the cups by rinsing them with hot water (N.B. you can use the hot water function).</li> </ul>
	The infuser has cooled down because 2/3 minutes have elapsed since the last coffee was made.	Before making the coffee, warm the infuser by using the Rinsing function to perform a rinse cycle (page 10).
	Low coffee temperature is set.	In the menu, set a higher coffee temperature.
The coffee is thin or not creamy enough.	The coffee is ground too coarsely.	Turn the grinding adjustment dial one click anticlockwise towards "1" while the coffee mill is in operation (fig. 28). Continue one click at a time until coffee delivery is satisfactory. The effect is only visible after delivering 2 coffees (see the section: "adjusting the coffee mill" on page 12).
	The coffee is unsuitable.	Use pre-ground coffee for espresso coffee makers
The coffee is delivered too slowly or a drop at a time.	The coffee is ground too finely.	Turn the grinding adjustment dial one click clockwise towards "7" while the coffee mill is in operation (fig. 28). Continue one click at a time until coffee delivery is satisfactory. The effect is only visible after delivering two coffees. (see the section "adjusting the coffee mill" on page 12).
Coffee does not come out of one of the spouts.	The spouts are blocked.	Clean the spouts with a toothpick (fig. 29B).
 <p>The milk does not come out of the milk spout.</p> <p>The milk contains large bubbles and squirts out of the milk spout or there is little froth .</p>	the milk container lid is dirty.	Clean the milk container lid as described in the section "cleaning the milk container".
	the milk is not cold enough or is not semi-skimmed.	Use skimmed or semi-skimmed milk at refrigerator temperature (about 5° c). If the result is not as you wished, try changing brand of milk.
	The froth adjustment dial is incorrectly adjusted.	Adjust following the instructions in the section "making drinks with milk".
	The milk container lid or froth adjustment dial is dirty	Clean the milk container lid and dial as described in the section "cleaning the milk container".
	The hot water/steam nozzle is dirty	Clean the nozzle as described in the section "cleaning the hot water/steam nozzle".
	 <p>The milk contains large bubbles there is little froth .</p>	The spout is dirty.
The appliance does not come on.	The connector is not inserted correctly.	Insert the connector as far as it will go in the socket at the back of the appliance.
	It is not plugged into the mains socket.	Plug into the mains socket.
	The main switch (A7) is not turned on.	Place the main switch in the I position (fig. 2).
The infuser cannot be extracted	The appliance has not been turned off correctly	Turn the appliance off by pressing the  button (page 10) and wait until the display is completely shut off. At this point the infuser is in the correct position and can be extracted.

## LIMITED WARRANTY

---

This warranty applies to all products with De'Longhi or Kenwood brand names.

### **What does the warranty cover?**

We warrant each appliance to be free from defects in material and workmanship. Our obligation under this warranty is limited to repair at our factory or authorized service center of any defective parts or part thereof, other than parts damaged in transit. In the event of a products replacement or return, the unit must be returned transportation prepaid. The repaired or replacement model will be returned at the company expense.

This warranty shall apply only if the appliance is used in accordance with the factory directions, which accompany it, and on an Alternating current ( AC ) circuit.

### **How long does the coverage last?**

This warranty runs for two years (2) from the purchase date found on your receipt and applies only to the original purchaser for use.

### **What is not covered by the warranty?**

The warranty does not cover defects or damage of the appliance, which result from repairs or alterations to the appliance outside our factory or authorized service centers, nor shall it apply to any appliance, which has been subject to abuse, misuse, negligence or accidents. Also, consequential and incidental damage resulting from the use of this product or arising out of any breach of contract or breach of this warranty are not recoverable under this warranty. Some states do not allow the exclusion or limitation of incidental or consequential damage, so the above limitation may not apply to you.

### **How do you get service?**

If repairs become necessary, see contact information below:

**U.S. Residents:** Please contact our toll free hotline at 1-866-528-8323 (1-866-Latte-Best) or log onto our website at [www.delonghi.com](http://www.delonghi.com)

**Residents of Canada:** Please contact our toll free hotline at 1-888-335-6644 or log onto our website at [www.delonghi.com](http://www.delonghi.com)

**Residents of Mexico:** Please contact our toll free number 01-800-711-8805 for assistance or log onto our website at [www.delonghi.com](http://www.delonghi.com)

The above warranty is in lieu of all other express warranties and representations. All implied warranties are limited to the applicable warranty period set forth above. This limitation does not apply if you enter into an extended warranty with De'Longhi. Some states/countries do not allow limitations on how long an implied warranty lasts, so the above exclusions may not apply to you. De'Longhi does not authorize any other person or company to assume for it any liability in connection with the sale or use of its appliance.

### **How does country law apply?**

This warranty gives you specific legal rights, and you may also have other rights, which vary from state to state/country to country.